



## **JCM Products Quick Reference Guide**

### **Optipay<sup>®</sup> System**



*NOTE: Due to advancements in related industry technologies and future product development, the information in this guide is subject to change without notice.*

For more information about product set-up, use, testing procedures and troubleshooting methods, please contact the Technical Support Division of Customer Service via the email addresses listed below:

#### **Americas**

**support@jcmglobal.com**

#### **Europe, UK, Africa, Russia & Middle East**

**support@jcmglobal.eu**

#### **Asia & Oceania**

**asiapactechsupport@jcmglobal.com**



**© 2013, JCM Global, Corporation**

**Part No. 960-000128R\_Rev. 5**

**Optipay® System**  
**QUICK REFERENCE**  
**TROUBLESHOOTING GUIDE**

**Table 1** Troubleshooting Descriptions

<b>DBV®-30X Bill Validator</b>		
<b>Description</b>	<b>Probable Cause</b>	<b>Possible Solutions</b>
Bill Rejection	DIP Switches not set properly	Set DIP Switches (See DIP Switch Chart for proper settings)
	Roller and/or Belts are excessively dirty	Clean bill path, rollers and belts with a damp cloth using a mild soap and water solution
	Not enough bills in Recycler or coins in Changer	Check float level setting for A-66 or Load the RC-10
	Denomination is disabled by vending machine	Make sure the machine is set to accept the rejected currency
No Activity	No power to the unit/ No LEDs visibly lit	Make sure all power harness are properly connected
	LEDs are blinking and would not accept bills	Check for proper software usage /ID protocol
	Unit still in test mode	Check for proper DIP Switch settings and machine settings
<b>RC-10 Recycler</b>		
<b>Description</b>	<b>Probable Cause</b>	<b>Possible Solutions</b>
RC-10 in Error Mode	No power to the RC	Make sure the harness from DBV is properly connected
	Cycles and goes into an error mode	Check for a bill jam and A-66 communication
	Cycles but will not accept bills	Check if the RC-10 is full

## Optipay® System

**Table 1** Troubleshooting Descriptions (Continued)

<b>A-66 Coin Changer</b>		
<b>Description</b>	<b>Probable Cause</b>	<b>Possible Solutions</b>
A-66 in Error Mode	No power to the unit	Make sure the power harness is properly connected
	Will not accept coins	Make sure all connections are in place and that the Green LED is lit
		Make sure cassette and mechanism are locked in place
	Will not dispense coins	Look for a jammed coin
		Make sure all coins are above the security level
	Coins are being dispensed but are not falling into the coin return	Check for anything blocking the coin return tray
	A Yellow or Red LED is blinking	Count the number of blinks and refer to the error code chart
	Communication failure	Check the harness for proper connection and reset power
Coins keep falling through into the coin return	Make sure the coin return lever moves freely	

## Optipay® System ERROR CODES

**Table 2 DBV-30X Error Codes**

Nº. of Flashes			Diagnostic Description
Red	Yel	Grn	
OFF	OFF	Solid On	DBV OK/ Ready
OFF	1	OFF	Cash Box full / check Cash Box condition
2	OFF	OFF	Stacker Error/ check Cash Box condition
3	OFF	OFF	Note Jammed / check note path
OFF	4	OFF	
OFF	10	OFF	Cash Box position/ check Cash Box seating
OFF	OFF	1 to 8	Last note rejected / if problem persists, either clean note path or contact JCM
OFF	OFF	9 to 10	Last note inhibited / rejected by DBV or host
OFF	OFF	11 to 15	Last note rejected / if problem persists, either clean note path or contact JCM

**Table 3 A-66 Error Codes**

Nº. of Flashes			Diagnostic Description
Red	Yel	Grn	
OFF	OFF	Solid On	Coin Changer is operational
OFF	OFF	Flashing	Filling level mode activated
OFF	Solid On	Solid On	Coin inserted was inhibited by the Vending Machine
OFF	1	OFF	Return lever pressed
OFF	2	OFF	Coins stuck in payout area
OFF	3	OFF	Coin Changer inhibited by the Vending Machine
OFF	4	OFF	Communication failure to Recycler
1	OFF	OFF	Error in upper portion of the coin Validator
2	OFF	OFF	Error in lower cassette/changer unit
3	OFF	OFF	Vending Machine no longer communicating with the Coin Changer (i. e., no communication occurred for 2 seconds)

## Optipay® System

Table 4 RC-10 Error Codes

Nº. of Flashes	Diagnostic Description
Green	
Solid On	Standby mode (Bill is ready to be accepted)
1	Recycler full
2	Recycler Jam (During initialization)
3	Recycler Jam (During bill dispensing)
4	Recycler Jam (During bill stacking)
5	Recycler motor speed error
6	Recycler motor lock error
7	Recycler sensor failure (entrance)
8	Recycler sensor failure (empty)
9	Recycler sensor failure (full)
10	Recycler Jam (in pusher mechanism zone)
11	Reserved
12	Reserved
13	DBV Motor Speed Error (Not Suitable for RC-10)
14	Reserved
15	Communication failure to changer

# Optipay® System

## DIP SWITCH SETTINGS

**Table 5 DBV-30X DIP Switch Assignments**

<b>DBV-30X DIP Switches</b>			
Block 1	Switch Number	ON	OFF
	1	Disable \$1	Enable \$1
	2	Disable \$5	Enable \$5
	3	Disable \$10	Enable \$10
	4	Disable \$20	Enable \$20
	5 Through 7	Reserved	Turn OFF
	8	Test Mode Access	Normal Operation

Block 2	Sw No.	Switches 1-4	ON	OFF				
	1	<b>Pulse Width Settings</b>						
	2	SW-1	SW-2	Pulse Width				
		OFF	OFF	50 ms / 300 ms				
		ON	OFF	50 ms / 50 ms				
		OFF	ON	80 ms / 120 ms				
	3	ON	ON	150 ms / 180 ms				
		<b>Pulse Count Settings</b>						
		4	SW-3	SW-4	Pulse Count			
			OFF	OFF	1 Pulse = \$1			
	ON		OFF	4 Pulses = \$1				
	OFF		ON	10 Pulses = \$1				
	5-7	ON	ON	20 Pulses = \$1				
			Reserved	OFF				
8				Select Pulse	Select Serial			

## Optipay® System

**Table 6** RC-10 DIP Switch Assignments

RC-10 DIP Switches			
Block	Switch Number	ON	OFF
	1	Recycle \$5	Recycle \$1
	2	Reserved	OFF
	3	All bills sent to Recycler*	Good bills sent to Recycler*
	4	Dispense all bills*	Do not dispense bills*

\* Switches #3 & #4 are only active in test mode.

**Table 7** A-66 DIP Switch Assignments

A-66 DIP Switches			
Block	Switch Number	ON	OFF
	1	Inhibit 0.05	Accept 0.05
	2	Inhibit 0.10	Accept 0.10
	3	Inhibit 0.25	Accept 0.25
	4	Inhibit 0.50	Accept 0.50
	5	Inhibit 1.00	Accept 1.00
	6	Inhibit 0.05 narrow band	Accept 0.05 narrow band
	7 and 8	Reserved - turn OFF	
	9	Pay-Out All RC-10 Bills	RC-10 Security Stack ON
	10	MDB Level 3	MDB Level 2

# Optipay® System

## MECHANICAL DIAGNOSTIC TESTS

**Table 8** DBV-30X Diagnostics

<b>Selecting the Desired Test Mode</b>	
Note: These tests can also be done using a Palm® Pilot™ PDA	
To select the desired test, perform the following steps:	
<ol style="list-style-type: none"> <li>1. Turn the DBV Power OFF</li> <li>2. Set DIP Switch #8 to ON</li> <li>3. Reapply Power to the DBV</li> <li>4. Set the desired Test DIP Switch listed below to ON</li> <li>5. Turn DIP Switch #8 OFF to begin the particular test mode</li> </ol>	
Test DIP Switch N <sup>o</sup> .	Test Function
1 ON	Feed motor forward rotation
2 ON	Feed motor reverse rotation
3 ON	Stacker test
4 ON	Running test <ol style="list-style-type: none"> <li>1. Normal: Condition LED Out (extinguished).</li> <li>2. Stacker Full: Yellow Condition LED Blinks once (1 time)</li> <li>3. Stacker Jam/Lock: Red Condition LED Blinks Twice (2 times).</li> <li>4. Acceptor Jam: Yellow Condition LED Blinks 4 times.</li> <li>5. Motor Speed: Red Condition LED Blinks 5 times.</li> <li>6. Motor Lock: Red Condition LED Blinks 6 times</li> <li>7. Cash Box error: Yellow Condition LED Blinks 10 times.</li> </ol>
5 ON	Insert prevention lever test <ol style="list-style-type: none"> <li>1. Normal: Condition LED Out (extinguished).</li> <li>2. Motor Lock-up: Green, Yellow &amp; Red Condition LEDs Blink 6 times.</li> <li>3. Sensor Abnormal: Green, Yellow &amp; Red Condition LEDs Blink 9 times.</li> </ol>
6 ON	Acceptor Sensor Test [Refer to Table 9 on page 10 concerning the Acceptor Sensor Test Details]
7 ON	Stacker Sensor Test [Refer to Table on page 10 concerning the Stacker Sensor Test Details]
1, 2, 3, & 4 ON	Acceptance Test
1 & 3 ON	Stacker motor forward test (Pusher plate stops at the home position) <ol style="list-style-type: none"> <li>1. Normal: Green, Yellow &amp; Red Condition LEDs Blink once (1 time).</li> <li>2. Fast: Green, Yellow &amp; Red Condition LEDs Blink twice (2 times).</li> <li>3. Slow: Green, Yellow &amp; Red Condition LEDs Blink 3 times.</li> <li>4. Abnormal: Green, Yellow &amp; Red Condition LEDs Blink 6 times.</li> </ol>



## Optipay® System

**Table 8** DBV-30X Diagnostics (Continued)

<b>Selecting the Desired Test Mode</b>	
Note: These tests can also be done using a Palm® Pilot™ PDA	
To select the desired test, perform the following steps:	
<ol style="list-style-type: none"> <li>1. Turn the DBV Power OFF</li> <li>2. Set DIP Switch #8 to ON</li> <li>3. Reapply Power to the DBV</li> <li>4. Set the desired Test DIP Switch listed below to ON</li> <li>5. Turn DIP Switch #8 OFF to begin the particular test mode</li> </ol>	
Test DIP Switch N <sup>o</sup> .	Test Function
1 & 3 ON	<p>Stacker motor forward test (Pusher plate stops at the home position)</p> <ol style="list-style-type: none"> <li>1. Normal: Green, Yellow &amp; Red Condition LEDs Blink once (1 time).</li> <li>2. Fast: Green, Yellow &amp; Red Condition LEDs Blink twice (2 times).</li> <li>3. Slow: Green, Yellow &amp; Red Condition LEDs Blink 3 times.</li> <li>4. Abnormal: Green, Yellow &amp; Red Condition LEDs Blink 6 times.</li> </ol>
2 & 3 ON	<p>Stacker motor reverse test (Pusher plate stops at the home position)</p> <ol style="list-style-type: none"> <li>1. Normal: Green, Yellow &amp; Red Condition LEDs Blink once (1 time).</li> <li>2. Fast: Green, Yellow &amp; Red Condition LEDs twice (2 times).</li> <li>3. Slow: Green, Yellow &amp; Red Condition LEDs Blink 3 times.</li> <li>4. Abnormal: Green, Yellow &amp; Red Condition LEDs Blink 6 times.</li> </ol>
1 & 2 ON*	<p>Pulse IF line test*</p> <ol style="list-style-type: none"> <li>1. [D/E] switch shifted to [D/E] side [Busy] LED will turn on.</li> <li>2. [Inline] switch shifted to [Inline] side [vend] LED will turn on.</li> <li>3. [Soft-R] switch shifted to [Soft-R] side [ABN] LED will turn on.</li> <li>4. [Full] LED flash for (500 ms interval).</li> </ol>
1 through 6 ON	<p>DIP Switch tests [Refer to the <b>DIP Switch Test</b> procedures outlined in Appendix A of the DBV-30X Operation and Maintenance Manual (JCM Part No. 960-000103R_Rev. 3 or greater) concerning these tests]. This Service Manual is available in PDF form for download at the JCM Website (<a href="http://www.jcm-american.com/support/tech_manuals.asp">http://www.jcm-american.com/support/tech_manuals.asp</a>).</p>

\* The Pulse IF Test requires the availability and use of an external VM-300/301 Power Supply Unit available as a separate item from JCM. Contact your local JCM Representative for further ordering details.

# Optipay® System

## SPECIFIC TEST DETAILS

**Table 9** DBV Acceptor Sensor Test Details

<b>Selecting the Acceptor Sensor Test Mode</b>	
Note: These tests can also be done using a Palm Pilot PDA	
To select the desired test, perform the following steps:	
<ol style="list-style-type: none"> <li>1. Turn the DBV Power OFF</li> <li>2. Set DIP Switch #8 to ON</li> <li>3. Set DIP Switch #6 to ON</li> <li>4. Reapply Power to the DBV</li> <li>5. Turn DIP Switch #8 OFF to begin the particular test mode</li> <li>6. Use DIP Switch #6 to turn the test ON and OFF</li> </ol> <p style="margin-left: 40px;">The Green, Yellow, and Red LEDs will light when the selected sensor is covered</p>	
Test DIP Switch №.	Test Function
1 ON	LEV (Lever to prevent continuous insertion)
2 ON	PSF (Entrance)
3 ON	PSML (Red Left)
4 ON	PSMR (Red Right)
5 ON	PSL (Red Left 3 IR)
6 ON	PSR (Red Right 3 IR)
7 ON	PSE (Exit)

**Table 10** DBV Stacker Sensor Test Details

<b>Selecting the Stacker Sensor Test Mode</b>	
Note: These tests can also be done using a Palm Pilot PDA	
To select the desired test, perform the following steps:	
<ol style="list-style-type: none"> <li>1. Turn the DBV Power OFF</li> <li>2. Set DIP Switch #8 to ON</li> <li>3. Set DIP Switch #7 to ON</li> <li>4. Reapply Power to the DBV</li> <li>5. Turn DIP Switch #8 OFF to begin the particular test mode</li> <li>6. Use DIP Switch #7 to turn the test ON and OFF</li> </ol> <p style="margin-left: 40px;">The Green, Yellow, and Red LEDs will light when the selected sensor is covered</p>	
Test DIP Switch №.	Test Function
1 ON	PSL (when there is a note detected by the transport's left sensor)
2 ON	Reserved
3 ON	PSR (when there is a note detected by the transport's right sensor)

## Optipay® System

**Table 10** DBV Stacker Sensor Test Details (Continued)

<b>Selecting the Stacker Sensor Test Mode</b>	
Note: These tests can also be done using a Palm Pilot PDA	
To select the desired test, perform the following steps:	
<ol style="list-style-type: none"> <li>1. Turn the DBV Power OFF</li> <li>2. Set DIP Switch #8 to ON</li> <li>3. Set DIP Switch #7 to ON</li> <li>4. Reapply Power to the DBV</li> <li>5. Turn DIP Switch #8 OFF to begin the particular test mode</li> <li>6. Use DIP Switch #7 to turn the test ON and OFF</li> </ol>	
The Green, Yellow, and Red LEDs will light when the selected sensor is covered	
4 ON	Home (when the pusher plate is in the home position)
5 ON	Box (Cash Box is set in position)
6 ON	Stacker motor encoder when covered
7 ON	Feed motor encoder when covered

**Table 11** A-66 Coin Changer Maintenance Keys

<b>A-66 Maintenance Key Functions</b>	
Key Label	Function
<b>L</b>	Press once to dispense coins from the Left tube
<b>ML</b>	Press once to dispense coins from the Middle Left tube
<b>MR</b>	Press once to dispense coins from the Middle Right tube
<b>R</b>	Press once to dispense coins from the Right tube
<b>+</b>	The Plus key has the multiple function uses of emptying tubes to preconfigured float levels and initiating the fill mode

## Optipay® System DOWNLOADING

---

**Table 12** Optipay Downloading Requirements

### **DBV-30X Equipment & Software Requirements**

The Palm Pilot and PSP-04 or DWN-03 software are needed for download to the DBV-30X.

Downloading to/from the DBV can be done either using a Palm Pilot® PDA or the serial port of a PC.

Detailed instructions and the related equipment requirements are found in the “Optipay BV Series Firmware Download and Memory Flashing Instructions” Guide (Part No. 960-100170RA) available for download or viewing at:

[http://www.jcm-american.com/support/tech\\_manuals.asp](http://www.jcm-american.com/support/tech_manuals.asp).

### **RC-10 Equipment & Software Requirements**

Software not required. The RC-10 is controlled by the Coin Changer and DBV.

### **A-66 Equipment & Software Requirements**

The Palm Pilot and Palm Flash software are needed to download to the A-66 Coin Changer.



# Optipay® System

## OPTIONAL OPTIPAY® VERTO™ MODULE Controls and Indicators

Figure 2 illustrates the Verto™ Module's primary controls and indicator LED Displays and DIP Switch locations.

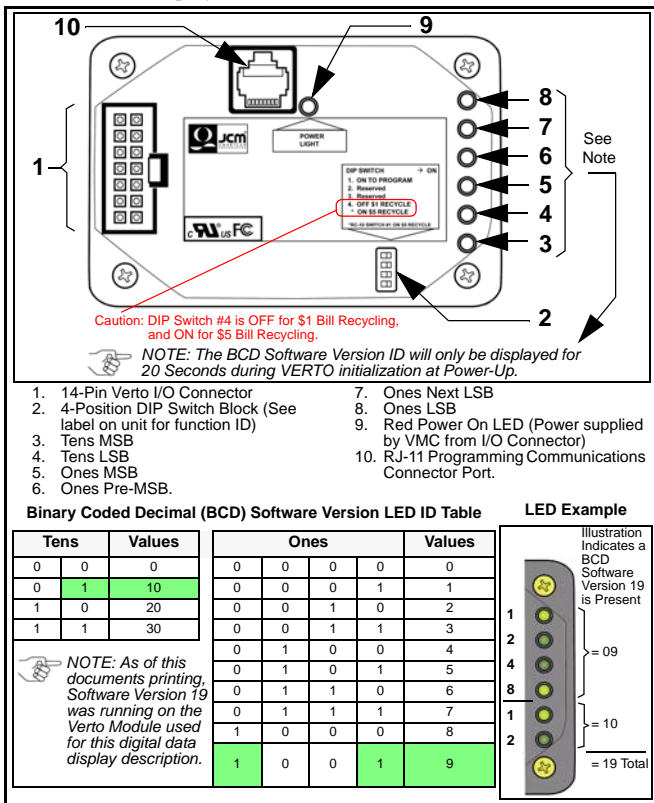

**Figure 2** Optipay Verto Module Controls and Indicators

## Optipay® System

### A-66 COIN CHANGER

### NRI EASY CONFIG™ INFORMATION

---

For customers still using an A-66 Coin Changer containing Firmware Version 375-101 or greater installed within them, the NRI/Crane Easy Config™ may be used to set various operating options for the unit. This is accomplished as follows:

1. Remove Power from the Vending Machine/Coin Changer.
2. Press upwards on the White Release Tab located at the upper right corner of the Coin Changer, and tilt the Validator Head forward until the 10 Position DIP Switch located on the back-side of the Validator Head is accessible.
3. Select the desired operating option from the NRI/Crane Easy Config™ Options Chart listed in Table 13 on page 16.
4. Set the Validator Head DIP Switch positions to match those shown in the Options Chart for the option required.
5. Reapply Power to the Vending Machine/Coin Changer. The desired option settings will be automatically stored into memory at this time.
6. If additional options are desired, repeat Steps 1 through 5.
7. If no further options are required, press the Validator Head backwards until it click-locks back into place in the Coin Changer chassis.
8. The Coin Changer is ready for normal operation.



*NOTE: On the Table 13 Options Chart, selecting the 'Set Configuration to Default' option will set the following parameters:*

- *MDB Level 2*
- *Keypad 'ON'*
- *Tube Empty Function for Bills 'ON'*
- *Float-up level = 100% for all tubes*
- *Empty Recycler Store 'OFF'.*

# Optipay® System

## A-66 NRI EASY CONFIG™ OPTIONS CHART

Table 13 NRI Easy Config™ Options Chart

OPTION SELECTION	SET DIP SWITCH N <sup>o</sup> . to --- >	ON
MDB Level 2	10 ----- >	ON
MDB Level 3	1 & 10 ----- >	ON
Keypad ON by VMC	2, & 10 ----- >	ON
Keypad ON	1, 2, & 10 ----- >	ON
Keypad OFF	3 & 10 ----- >	ON
Tube empty function for bills ON	1, 3 & 10 ----- >	ON
Tube empty function for bills OFF	2, 3 & 10 ----- >	ON
Working with Float Levels	1, 2, 3 & 10 ----- >	ON
Float Level = 50% for all tubes	4 & 10 ----- >	ON
Float Level = 75% for all tubes	1, 4 & 10 ----- >	ON
Float Level = 100% for all tubes	2, 4 & 10 ----- >	ON
Enable Token Acceptance	1, 2, 4 & 10 ----- >	ON
Disable Token Acceptance	3, 4 & 10 ----- >	ON
Empty Recycler Store ON	1, 3, 4 & 10 ----- >	ON
Empty Recycler Store OFF	2, 3, 4 & 10 ----- >	ON
Set Configuration to Default	1, 2, 3, 4 & 10 ----- >	ON
Tube Set: N D Q Q	5 & 10 ----- >	ON
Tube Set: N D Q \$ <sup>†</sup>	1, 5 & 10 ----- >	ON
Tube Set: Q Q Q \$	2, 5 & 10 ----- >	ON
Tube Set: N D N Q	1, 2, 5 & 10 ----- >	ON
Tube Set: N D N \$	3, 5 & 10 ----- >	ON
Tube Set: N N Q \$	1, 3, 5 & 10 ----- >	ON
Tube Set: N N Q Q	2, 3, 5 & 10 ----- >	ON
Tube Set: N N \$ \$	1, 2, 3, 5 & 10 ----- >	ON
Tube Set: Q N Q Q	4, 5 & 10 ----- >	ON
Tube Set: Q N Q \$	1, 4, 5 & 10 ----- >	ON
Tube Set: Q N \$ \$	2, 4, 5 & 10 ----- >	ON
Tube Set: Q Q Q Q	1, 2, 4, 5 & 10 ----- >	ON
Tube Set: Q Q \$ \$	3, 4, 5 & 10 ----- >	ON
Tube Set: For Future Use	1, 3, 4, 5 & 10 ----- >	ON
Tube Set: For Future Use	2, 3, 4, 5 & 10 ----- >	ON
Tube Set: For Future Use	1, 2, 3, 4, 5 & 10 ----- >	ON
Enable Channel 0...15 (Binary)	X, X, X, X, X,† 6 & 10 ----- >	ON
Inhibit Channel 0 ... 15 (Binary)	X, X, X, X, X, 5, 6 & 10 ----- >	ON



\* N = Nickel, D = Dime, Q = Quarter & \$ = Dollar Coin

† Note: X, X, X, X = Binary Code for 0 ..... 15



## Optipay® System PREVENTIVE MAINTENANCE

**Table 14** DBV-30X PM Requirements

<b>DBV-30X Preventive Maintenance Requirements</b>	
<b>Unit</b>	<b>Requirement</b>
DBV-30X Bill Validator	<p>It is important to keep the bill path, rollers, and belts clean. The sensor lenses are transparent, and made of a polymer material. Handle them with care. To clean the lenses, use a lint-free cloth and a mild non- abrasive detergent, such as liquid soap mixed with water. After wiping down the unit use canned air or compressor to blow out the dust.</p> <p> <b>Warning: Do not use alcohol, paint thinner or citrus based solutions for cleaning ANY surfaces!</b></p> <p> <b>Important NOTE:</b> After wiping, inspect the lenses to ensure that none of the lenses are still dirty or smeared.</p>
RC-10 Recycler	This unit can be blown out with air. Belts do not require cleaning.
A-66 Coin Changer	To clean the A-66 Coin Changer use a lint free cloth and mild non-abrasive detergent and use canned air or a compressor to blow out the unit after it is cleaned and wiped down.

## Optipay® System

THIS PAGE INTENTIONALLY LEFT BLANK

**Optipay® System**

# **JCM International Offices**

## **Japan Cash Machine Germany GmbH**

Muendelheimer Weg 60  
D-40472 Duesseldorf Germany  
Phone: +49-211-530-645-60  
Fax: +49-211-530-645-85  
E-mail: support@jcmglobal.eu

## **JCM United Kingdom Ltd.**

Unit B, Third Avenue  
Denbigh West Business Park  
Bletchley Milton Keynes  
Buckinghamshire MK1 1EJ  
Phone: +44 (0) 190-837-7331  
Fax: +44 (0) 190-837-7834  
E-mail: info@jcmglobal.eu

## **JCM Gold (HK) Ltd.**

Unit 1-7, 3/F., Favor Industrial Centre  
2-6 Kin Hong Street, Kwai Chung,  
N.T. Hong Kong  
Phone: +852-2429-7187  
Fax: +852-2929-7003  
E-mail: asiapactechsupport@jcmglobal.com

---

**Optipay® System  
Quick Reference Guide**



# **JCM International Offices**

## **JCM American**

925 Pilot Road, Las Vegas, NV 89119  
Phone: +1-702-651-0000  
Fax: +1-702-644-5512  
E-mail: support@jcmglobal.com

## **USA Regional Offices**

### **Illinois Office**

3000 Dundee Road, Ste. #402  
Northbrook, IL 60062  
Office: (847) 418-3354  
Fax: (847) 418-3357

### **Mississippi Office**

4063 Ginger Drive, Ste. B  
D'Iberville, MS 39540  
Office: (228) 344-8601  
Fax: (228) 354-8608

